



ADDENDUM 1

January 21, 2020

ITB AP 12-20

VPS Fuel Farm Fall Protection for Destin-Fort Walton Beach Airport

Please find attached the Documents for the above referenced Addendum No. 1. This Addendum is hereby made a part of the Contract Documents and Specifications of the above referenced project. All other requirements of the original Contract Documents and Specifications shall remain effective in their respective order.

Total pages for Addendum No. 1. is a total of 22 pages. Please insert this addendum's Attachments A and B into your copy of the Project Bid Documents.

Note: The bidder shall acknowledge receipt of this addendum on the Bid Form, Page BF-1 in the space provided.

Note: The ITB Opening Date & Time remains unchanged.

ADDENDUM NO. 1
FUEL FARM FALL PROTECTION FOR
DESTIN-FORT WALTON BEACH AIRPORT
(ITB AP 12-20)

Date of Issue: January 21, 2020

Bid Submittal Deadline: January 29, 2020 @ 3:00 p.m. (Central Standard Time) (unchanged)

Notice to all Plan Holders: Please insert this addendum's Attachments A and B into your copy of the Project Bid Documents.

The following changes to the Project Documents and Specifications are issued by the Engineer and shall have the same force and effect as though part of the original issue:

A. Changes to the Project Documents and Specifications:

1. Respondent's Acknowledgement **ADD** Respondent's Acknowledgement page, attached as **Attachment A** (1 page) hereto. ***This page must be signed and returned with the bid submittal.***
2. Vendors on Scrutinized Companies List **ADD** Vendors on Scrutinized Companies List page, attached as **Attachment B** (1 page) hereto. ***This page must be signed and returned with the bid submittal.***

B. Changes to the Drawings:

1. Sheet T-001 **REVISE** Note 2 to read as follows:

"...for review prior to any work being performed. No welding shall be allowed inside of the fuel farm fence. All welding shall occur at least 100 ft from any fuel tanks and the completed assemblies transported to the installation location."
2. Sheet T-001 **ADD** Note 5 as follows:

"The maximum height for a crane is 100 ft above ground level."
3. Sheet S-201 **REVISE** Structural Framing Elev. detail note to read as follows:

"Contractor shall coordinate existing valves with new bracing **to ensure there are no conflicts**, provide shop drawings indicating valve location prior to construction"

C. Additional Information:

1. Responses to Questions Please find attached responses to plan holder questions attached as **Attachment C** (9 pages) hereto.
2. Pre-Bid Conference Minutes Please find attached the Pre-Bid Conference minutes attached as **Attachment D** (9 pages) hereto.

END OF ADDENDUM NO. 1



INVITATION TO BID (ITB) & RESPONDENT'S ACKNOWLEDGEMENT

ITB TITLE:

**VPS FUEL FARM FALL PROTECTION FOR
DESTIN-FORT WALTON BEACH AIRPORT**

ITB NUMBER:

ITB 12-20

ISSUE DATE:

December 30, 2020

LAST DAY FOR QUESTIONS:

January 15, 2020 3:00 P.M. CST

ITB OPENING DATE & TIME:

January 29, 2020 3:00 P.M. CST

NOTE: BIDS RECEIVED AFTER THE BID OPENING DATE & TIME WILL NOT BE CONSIDERED.

Okaloosa County, Florida solicits your company to submit a bid on the above referenced goods or services. All terms, specifications and conditions set forth in this ITB are incorporated into your response. A bid will not be accepted unless all conditions have been met. All bids must have an authorized signature in the space provided below. All bids must be sealed and received by the Okaloosa County Crestview Courthouse BCC Records by the "ITB Opening Date & Time" referenced above. The official clock for the purpose of receiving bids is located in the Okaloosa County Courthouse located at 101 East James Lee Blvd, Room #282, Crestview, FL 32536. All envelopes containing sealed bids must reference the "ITB Title", "ITB Number" and the "ITB Opening Date & Time". Okaloosa County is not responsible for lost or late delivery of bids by the U.S. Postal Service or other delivery services used by the respondent. Neither faxed nor electronically submitted bids will be accepted. Bids may not be withdrawn for a period of ninety (90) days after the bid opening unless otherwise specified.

RESPONDENT ACKNOWLEDGEMENT FORM BELOW MUST BE COMPLETED, SIGNED, AND RETURNED AS PART OF YOUR BID. BIDS WILL NOT BE ACCEPTED WITHOUT THIS FORM, SIGNED BY AN AUTHORIZED AGENT OF THE RESPONDENT.

COMPANY NAME _____

MAILING ADDRESS _____

CITY, STATE, ZIP _____

FEDERAL EMPLOYER'S IDENTIFICATION NUMBER (FEIN): _____

TELEPHONE: _____ EXT: _____ FAX: _____

EMAIL: _____

I CERTIFY THAT THIS BID IS MADE WITHOUT PRIOR UNDERSTANDING, AGREEMENT, OR CONNECTION WITH ANY OTHER RESPONDENT SUBMITTING A BID FOR THE SAME MATERIALS, SUPPLIES, EQUIPMENT OR SERVICES, AND IS IN ALL RESPECTS FAIR AND WITHOUT COLLUSION OR FRAUD. I AGREE TO ABIDE BY ALL TERMS AND CONDITIONS OF THIS BID AND CERTIFY THAT I AM AUTHORIZED TO SIGN THIS BID FOR THE RESPONDENT.

AUTHORIZED SIGNATURE: _____

PRINTED NAME: _____

TITLE: _____

DATE: _____

VENDORS ON SCRUTINIZED COMPANIES LISTS

By executing this Certificate, the bid proposer, certifies that it is not: (1) listed on the Scrutinized Companies that Boycott Israel List, created pursuant to section 215.4725, Florida Statutes, (2) engaged in a boycott of Israel, (3) listed on the Scrutinized Companies with Activities in Sudan List or the Scrutinized Companies with Activities in the Iran Petroleum Energy Sector List, created pursuant to section 215.473, Florida Statutes, or (4) engaged in business operations in Cuba or Syria. Pursuant to section 287.135(5), Florida Statutes, the County may disqualify the bid proper immediately or immediately terminate any agreement entered into for cause if the bid proposer is found to have submitted a false certification as to the above or if the Contractor is placed on the Scrutinized Companies that Boycott Israel List, is engaged in a boycott of Israel, has been placed on the Scrutinized Companies with Activities in Sudan List or the Scrutinized Companies with Activities in the Iran Petroleum Energy Sector List, or has been engaged in business operations in Cuba or Syria, during the term of the Agreement. If the County determines that the bid proposer has submitted a false certification, the County will provide written notice to the bid proposer. Unless the bid proposer demonstrates in writing, within 90 calendar days of receipt of the notice, that the County's determination of false certification was made in error, the County shall bring a civil action against the bid proposer. If the County's determination is upheld, a civil penalty shall apply, and the bid proposer will be ineligible to bid on any Agreement with a Florida agency or local governmental entity for three years after the date of County's determination of false certification by bid proposer.

As the person authorized to sign this statement, I certify that this firm complies fully with the above requirements.

DATE: _____

SIGNATURE: _____

COMPANY: _____

NAME: _____
(Typed or Printed)

ADDRESS: _____

TITLE: _____

E-MAIL: _____

PHONE NO.: _____

**Responses to Plan Holder Questions
VPS Fuel Farm Fall Protection
(ITB AP 12-20)
January 21, 2020**

1. What type of fuel is stored in the tanks?

Response: Tanks 1 and 2 contain Mogas and Tanks 3 through 8 contain Jet-A.

2. What will be the status of the tank levels prior to welding? (Full or cleaned)?

Response: The tanks will be full.

3. Is a MSDS available for the fuels in question?

Response: Yes. Fuels are Jet-A and regular unleaded gasoline (MOGAS). Fuel farm operator can provide MSDS sheets if required prior to construction.

4. Are the tanks lined or coated internally?

Response: The tanks are coated internally.

5. Do the exterior coatings contain lead?

Response: Unknown.

6. Is there access for a crane or forklift all the way around the containment, and adjacent to the wall?

Response: The contractor shall visit the site to determine if there is adequate space to maneuver a crane or forklift around the containment area.

7. Will the underground conditions support a crane or lift?

Response: The contractor shall visit the site to determine if the underground conditions can support a crane or lift. Plywood or steel plates may be required to support certain pieces of equipment.

8. How close can we get to the tanks to figure center pin distance and lift plants for a crane or forklift?

Response: Cranes or forklifts may not be placed within the containment area, but can be placed adjacent to the containment wall if there is sufficient room.

9. Will we have to provide our own temporary facilities and power source?

Response: Yes.

10. Are data sheets available for the tanks? Diameter, length, material, thickness, Inc.

Response: The data sheets for Tanks 7 and 8 are attached. The data sheets for Tanks 1 through 6 are not available at this time.

11. Do the structural connections require a review or seal from an engineer?

Response: No connections are shown on the plans.

12. Are there any power lines over head or impeding the area?

Response: There are over-head power lines in the area, and the bidder shall conduct a site visit to determine if there are any over head power lines that will need to be considered.

13. Is there a maximum height restriction in the area?

Response: The maximum crane height is 100 ft above ground level.

14. Is there a hot work procedure in place for this area? And can we access a copy? Is should address vents, fumes, etc.

Response: No. Eglin Fire Department was at one time requiring a hot works permit but suspended requirement. Pending any requirement from the construction permit, at a minimum the contractor will be required to notify the Airport prior to any welding operations and a designated area close to the project but not inside the fenced area of the fuel farm.

15. The pictures make me think some electrical and instrumentation will need to be relocated or the platforms raised. Will others move the E&I?

Response: Rerouting fuel lines for Tanks 7 and 8 are required as shown on Sheet S-101. The contractor shall determine the means and methods to relocate these lines.

16. Can the platforms be raised about 1'-0"?

Response: No, the intent is to sit on top of the tanks in a saddle.

17. Can you provide the original manufacturer of the fuel tanks? Can you provide specs for the welding procedures of the pay eye?

Response: See response to Question 10. Pad eye welding requirements are specified on Sheet S-100. The contractor shall submit their proposed method of welding for approval prior to construction.



Protective & Marine Coatings

ENVIROLASTIC® 940 DTM POLYASPARTIC URETHANE

PART A
PART B

B65-940
B65V940

SERIES
HARDENER

Revised: October 31, 2016

PRODUCT INFORMATION

5.52

PRODUCT DESCRIPTION

ENVIROLASTIC 940 DTM is a high build, direct-to-metal polyaspartic urethane coating that can be applied in a single coat. This fast drying formula reduces dirt pick up, improves productivity and can be applied at temperatures as low as 35°F.

- Single coat application
- Corrosion resistant
- Cures quickly to improve productivity
- No gassing
- Outstanding application properties
- Direct to metal
- High film build in one coat

PRODUCT CHARACTERISTICS

Finish:	Gloss
Color:	Wide range of colors possible
Volume Solids:	68% ± 2%, mixed, may vary by color
Weight Solids:	80% ± 2%, mixed, may vary by color
VOC (EPA Method 24):	265 g/L; 2.21 lb/gal, mixed, may vary by color
Mix Ratio:	2:1 by volume

Recommended Spreading Rate per coat:

	Minimum	Maximum
Wet mils (microns)	9.0 (225)	13.0 (325)
Dry mils (microns)	6.0 (150)	9.0 (225)
~Coverage sq ft/gal (m²/L)	121 (3.0)	182 (4.5)
Theoretical coverage sq ft/gal (m²/L) @ 1 mil / 25 microns dft	1089 (26.7)	

NOTE: Brush or roll application may require multiple coats to achieve maximum film thickness and uniformity of appearance.

Drying Schedule @ 9.0 mils wet (225 microns):

	35°F/1.6°C	50°F/10°C	77°F/25°C 50% RH	120°F/49°C
To touch:	5 hours	3 hours	1 hour	30 minutes
To handle:	16 hours	7 hours	2 hours	1 hour
To recoat:				
minimum:	16 hours	7 hours	2 hours	1 hour
maximum:	3 months	3 months	3 months	45 days
To cure:	7 days	7 days	4 days	2 days
Pot Life:	4 hours	3 hours	2 hours	30 minutes
Sweat-in-Time:	None required			

*If maximum recoat time is exceeded, abrade surface before recoating.
Drying time is temperature, humidity, and film thickness dependent.*

Shelf Life:	Part A - 24 months, unopened Part B - 12 months, unopened Store indoors at 40°F (4.5°C) to 100°F (38°C).
Flash Point:	57°F (14°C), mixed (Seta Flash)
Reducer/Clean Up:	Reducer R7K216

RECOMMENDED USES

- Direct to properly prepared steel and galvanizing in industrial environments
- Replaces conventional epoxy/urethane systems
- Ideal for maintenance or new construction applications
- Suitable for use in USDA inspected facilities
- Acceptable for use in high performance architectural applications
- Suitable for use in the Mining & Minerals Industry

PERFORMANCE CHARACTERISTICS

Substrate*: Steel

Surface Preparation*: SSPC-SP10/NACE 2

System Tested*:

1 ct. Envirolastic 940 DTM @ 6.0-9.0 mils (150-225 microns) dft
*unless otherwise noted below

Test Name	Test Method	Results
Abrasion Resistance	ASTM D4060, CS17 wheel, 1000 cycles, 1 kg load	148 mg loss
Adhesion	ASTM D4541	2800 psi
Corrosion Weathering	ASTM D5894	Blisters 10, Rust 10, Scribe Creepage 8
Direct Impact Resistance	ASTM D2794	45 in. lb.
Dry Heat Resistance	ASTM D2485	200°F (93°C)
Pencil Hardness	ASTM D3363	H
Salt Fog	ASTM B117 2000 hours	Blisters 2F-2M, Rust 10, Scribe Creepage 8



Protective
&
Marine
Coatings

ENVIROLASTIC® 940 DTM POLYASPARTIC URETHANE

PART A
PART B

B65-940
B65V940

SERIES
HARDENER

Revised: October 31, 2016

PRODUCT INFORMATION

5.52

RECOMMENDED SYSTEMS

	Dry Film Thickness / ct.	
	Mils	(Microns)
Steel:		
1 ct. Envirolastic 940 DTM	6.0-9.0	(150-225)
Galvanizing:		
1 ct. Envirolastic 940 DTM	6.0-9.0	(150-225)
Steel, if primer is required:		
1 ct. Corothane I GalvaPac Zinc Primer	3.0-4.0*	(75-100)
1 ct. Envirolastic 940 DTM	6.0-9.0	(150-225)
Previously Painted Surfaces:		
1 ct. Envirolastic 940	6.0-9.0	(150-225)

other acceptable high performance primers

Fast Clad Zinc HS
Macropoxy 646 Epoxy
Steel Spec Epoxy Primer
Zinc Clad III HS
Zinc Clad IV

The systems listed above are representative of the product's use and other other systems may be appropriate. Please contact Sherwin-Williams for compatibility questions.

SURFACE PREPARATION

Surface must be clean, dry, and in sound condition. Remove all oil, dust, grease, dirt, loose rust, and other foreign material to ensure adequate adhesion.

Refer to product Application Bulletin for detailed surface preparation information.

DISCLAIMER

The information and recommendations set forth in this Product Data Sheet are based upon tests conducted by or on behalf of The Sherwin-Williams Company. Such information and recommendations set forth herein are subject to change and pertain to the product offered at the time of publication. Consult your Sherwin-Williams representative to obtain the most recent Product Data Information and Application Bulletin.

Minimum recommended surface preparation:

Iron & Steel: SSPC-SP6/NACE 3, 2 mil (50 micron) profile

Galvanizing: SSPC-SP16, 2 mil (50 micron) profile

Surface Preparation Standards

Condition of Surface	ISO 8501-1 BS7079:A1	Swedish Std. SIS055900	SSPC	NACE
White Metal	Sa 3	Sa 3	SP 5	1
Near White Metal	Sa 2.5	Sa 2.5	SP 10	2
Commercial Blast	Sa 2	Sa 2	SP 6	3
Brush-Off Blast	Sa 1	Sa 1	SP 7	4
Hand Tool Cleaning	Rusted C St 2	C St 2	SP 2	-
Pitted & Rusted	D St 2	D St 2	SP 2	-
Power Tool Cleaning	Rusted C St 3	C St 3	SP 3	-
Pitted & Rusted	D St 3	D St 3	SP 3	-

TINTING

Tint with Maxitoner colorants only into Part A Ultra Deep at 100% tint strength and 150% tint strength for Extra White. Five minutes minimum mixing on a mechanical shaker is required for complete mixing of color.

APPLICATION CONDITIONS

Temperature: 35°F (1.6°C) minimum, 120°F (49°C) maximum (air, surface, and material)
At least 5°F (2.8°C) above dew point
Relative humidity: 85% maximum
Refer to product Application Bulletin for detailed application information.

ORDERING INFORMATION

Packaging:

Part A: ~2 qts. (1.9L) in a 1 gallon can
Part B: ~1 qt. (0.95L) in a 1 quart can

Part A: ~3 gallons (12.04L) in a 5 gallon pail
Part B: ~1.66 gallons (6.28L) in a 2 gallon pail

Weight: 11.4 ± 0.2 lb/gal ; 1.4 Kg/L
mixed, may vary with color

SAFETY PRECAUTIONS

Refer to the MSDS sheet before use.
Published technical data and instructions are subject to change without notice. Contact your Sherwin-Williams representative for additional technical data and instructions.

WARRANTY

The Sherwin-Williams Company warrants our products to be free of manufacturing defects in accord with applicable Sherwin-Williams quality control procedures. Liability for products proven defective, if any, is limited to replacement of the defective product or the refund of the purchase price paid for the defective product as determined by Sherwin-Williams. NO OTHER WARRANTY OR GUARANTEE OF ANY KIND IS MADE BY SHERWIN-WILLIAMS, EXPRESSED OR IMPLIED, STATUTORY, BY OPERATION OF LAW OR OTHERWISE, INCLUDING MERCHANTABILITY AND FITNESS FOR A PARTICULAR PURPOSE.



**Protective
&
Marine
Coatings**

**ENVIROLASTIC® 940 DTM
POLYASPARTIC URETHANE**

**PART A
PART B**

**B65-940
B65V940**

**SERIES
HARDENER**

Revised: October 31, 2016

APPLICATION BULLETIN

5.52

SURFACE PREPARATIONS

Surface must be clean, dry, and in sound condition. Remove all oil, dust, grease, dirt, loose rust, and other foreign material to ensure adequate adhesion.

Iron & Steel

Remove all oil and grease from surface by Solvent Cleaning per SSPC-SP1. Minimum surface preparation is Commercial Blast Cleaning per SSPC-SP6/NACE 3. For better performance, use Near White Metal Blast Cleaning per SSPC-SP10/NACE 2. Blast clean all surfaces using a sharp, angular abrasive for optimum surface profile (2 mils / 50 microns). Prime any bare steel the same day as it is cleaned or before flash rusting occurs.

Aluminum

Remove all oil, grease, dirt, oxide and other foreign material by Solvent Cleaning per SSPC-SP1. Primer required.

Galvanized Steel

Surface Preparation Specification SSPC-SP 16 must be followed obtaining a surface profile of minimum 2.0 mils (50 microns).

Previously Painted Surfaces

If in sound condition, clean the surface of all foreign material. Smooth, hard or glossy coatings and surfaces should be dulled by abrading the surface. Apply a test area, allowing paint to dry one week before testing adhesion. If adhesion is poor, or if this product attacks the previous finish, removal of the previous coating may be necessary. If paint is peeling or badly weathered, clean surface to sound substrate and treat as a new surface as above.

APPLICATION CONDITIONS

Temperature: 35°F (1.6°C) minimum, 120°F (49°C) maximum (air, surface, and material)
At least 5°F (2.8°C) above dew point

Relative humidity: 85% maximum

APPLICATION EQUIPMENT

The following is a guide. Changes in pressures and tip sizes may be needed for proper spray characteristics. Always purge spray equipment before use with listed reducer. Any reduction must be compliant with existing VOC regulations and compatible with the existing environmental and application conditions.

Reducer/Clean Up

Above 80°FReducer R7K216
Below 80°FMEK, R6K10
Brush and roll.....Reducer R7K216

Airless Spray

Pump.....30:1
Pressure.....2800 - 3000 psi
Hose.....3/8" ID
Tip0.017" - .021"
Filter60 mesh
Reduction.....As needed up to 5% by volume

Conventional Spray

GunBinks 95
Cap63P
Fluid Tip67
Atomization Pressure.....50-70 psi
Fluid Pressure.....20-25 psi
Reduction.....As needed, up to 10% by volume

Brush (small areas only)

Brush.....Natural bristle
Reduction.....As needed up to 5% by volume

Roller (small areas only)

Cover1/4" woven with solvent resistant core
Reduction.....As needed up to 5% by volume

Surface Preparation Standards

Condition of Surface	ISO 8501-1 BS7079:A1	Swedish Std. SIS055900	SSPC	NACE
White Metal	Sa 3	Sa 3	SP 5	1
Near White Metal	Sa 2.5	Sa 2.5	SP 10	2
Commercial Blast	Sa 2	Sa 2	SP 6	3
Brush-Off Blast	Sa 1	Sa 1	SP 7	4
Hand Tool Cleaning	CC St 2	CC St 2	SP 2	-
Pitted & Rusted	DC St 2	DC St 2	SP 3	-
Rusted	CC St 3	CC St 3	SP 3	-
Power Tool Cleaning	DC St 3	DC St 3	SP 3	-

If specific application equipment is not listed above, equivalent equipment may be substituted.



Protective & Marine Coatings

ENVIROLASTIC® 940 DTM POLYASPARTIC URETHANE

PART A
PART B

B65-940
B65V940

SERIES
HARDENER

Revised: October 31, 2016

APPLICATION BULLETIN

5.52

APPLICATION PROCEDURES

Surface preparation must be completed as indicated.

Mix contents of each component thoroughly with low speed power agitation. Make certain no pigment remains on the bottom of the can. Then combine 2 parts by volume of Part A with 1 part by volume of Part B. Thoroughly agitate the mixture with power agitation.

If reducer solvent is used, add only after both components have been thoroughly mixed.

Apply paint at the recommended film thickness and spreading rate as indicated below:

Recommended Spreading Rate per coat:

	Minimum	Maximum
Wet mils (microns)	9.0 (225)	13.0 (325)
Dry mils (microns)	6.0 (150)	9.0 (225)
~Coverage sq ft/gal (m ² /L)	121 (3.0)	182 (4.5)
Theoretical coverage sq ft/gal (m ² /L) @ 1 mil / 25 microns dft	1089 (26.7)	

NOTE: Brush or roll application may require multiple coats to achieve maximum film thickness and uniformity of appearance.

Drying Schedule @ 9.0 mils wet (225 microns):

	@ 35°F/1.6°C	@ 50°F/10°C	@ 77°F/25°C 50% RH	@ 120°F/49°C
To touch:	5 hours	3 hours	1 hour	30 minutes
To handle:	16 hours	7 hours	2 hours	1 hour
To recoat:				
minimum:	16 hours	7 hours	2 hours	1 hour
maximum:	3 months	3 months	3 months	45 days
To cure:	7 days	7 days	4 days	2 days
Pot Life:	4 hours	3 hours	2 hours	30 minutes
Sweat-in-Time:	None required			

If maximum recoat time is exceeded, abrade surface before recoating. Drying time is temperature, humidity, and film thickness dependent.

Application of coating above maximum or below minimum recommended spreading rate may adversely affect coating performance.

CLEAN UP INSTRUCTIONS

Clean spills and spatters immediately with MEK, R6K10. Clean tools immediately after use with MEK, R6K10. Follow manufacturer's safety recommendations when using any solvent.

DISCLAIMER

The information and recommendations set forth in this Product Data Sheet are based upon tests conducted by or on behalf of The Sherwin-Williams Company. Such information and recommendations set forth herein are subject to change and pertain to the product offered at the time of publication. Consult your Sherwin-Williams representative to obtain the most recent Product Data Information and Application Bulletin.

PERFORMANCE TIPS

Stripe coat all crevices, welds, and sharp angles to prevent early failure in these areas.

When using spray application, use a 50% overlap with each pass of the gun to avoid holidays, bare areas, and pinholes. If necessary, cross spray at a right angle.

Spreading rates are calculated on volume solids and do not include an application loss factor due to surface profile, roughness or porosity of the surface, skill and technique of the applicator, method of application, various surface irregularities, material lost during mixing, spillage, overthinning, climatic conditions, and excessive film build.

Excessive reduction of material can affect film build, appearance, and adhesion.

Do not use Quik-Thane Urethane Accelerator.

Do not apply the material beyond recommended pot life.

Do not mix previously catalyzed material with new.

Not intended for use with universal primers

In order to avoid blockage of spray equipment, clean equipment before use or before periods of extended downtime with MEK, R6K10.

Mixed coating is sensitive to water. Use water traps in all air lines. Moisture contact can reduce pot life and affect gloss and color.

Refer to Product Information sheet for additional performance characteristics and properties.

SAFETY PRECAUTIONS

Refer to the MSDS sheet before use.

Published technical data and instructions are subject to change without notice. Contact your Sherwin-Williams representative for additional technical data and instructions.

WARRANTY

The Sherwin-Williams Company warrants our products to be free of manufacturing defects in accord with applicable Sherwin-Williams quality control procedures. Liability for products proven defective, if any, is limited to replacement of the defective product or the refund of the purchase price paid for the defective product as determined by Sherwin-Williams. NO OTHER WARRANTY OR GUARANTEE OF ANY KIND IS MADE BY SHERWIN-WILLIAMS, EXPRESSED OR IMPLIED, STATUTORY, BY OPERATION OF LAW OR OTHERWISE, INCLUDING MERCHANTABILITY AND FITNESS FOR A PARTICULAR PURPOSE.

FLAMESHIELD® LIMITED WARRANTY
Limitations of Liability and Disclaimer

What is Covered by this Warranty

Provided that the conditions set forth below are satisfied, the steel tank manufacturer identified with the tank (hereinafter referred to as "Warrantor") warrants the FLAMESHIELD® product for 30 years following delivery of the product to the tank owner at the time of the original installation ("the Owner"), against any of the following events which may occur, provided the event occurs under operating conditions covered by this Warranty: (i) against release of stored product from the FLAMESHIELD® secondary containment system; (ii) against failure of the primary tank caused by non-corrosion related cracking, breakup or collapse; and (iii) perforation of the primary tank caused by internal corrosion as long as the product stored within the tank is compatible with steel. In addition, the Warrantor warrants the tank against failure due to defective materials and workmanship for up to one (1) year following the delivery of the tank to the Owner.

Conditions to Warranty Effectiveness

The limited warranties set forth herein are subject to the following conditions:

1. The FLAMESHIELD® product must be: (i) the Original Aboveground Installation within the Continental United States of America, Alaska, Hawaii, and the Commonwealth of Puerto Rico or Canada; (ii) was fabricated by the Warrantor so as to meet the F921® and/or F911® Specification(s); and (iii) was installed and maintained in accordance with the applicable FLAMESHIELD® Specification and the applicable FLAMESHIELD® Installation Instructions that were in effect on the date of shipment by the Warrantor, any subsequent maintenance procedures of which the Owner has written notice, and any applicable governmental codes and regulations. Refer to the Installation Instructions on the back of this document for technical requirements concerning relocation of this tank by the original owner, in order to retain warranty eligibility. Tanks remaining in their original installation location will retain warranty eligibility if the facility where the tank is installed is sold to a new owner.
2. This Limited Warranty is not valid unless, and until, the Warranty Validation Card is fully completed by the Owner and returned to Steel Tank Institute (STI) within 30 days after the date of tank installation, or 90 days after the Warrantor's shipment of the tank, whichever comes first.
3. Upon discovery of a suspected covered failure or leak by the Owner, the Owner shall give the Warrantor written notice of the suspected failure or leak and permit the Warrantor or its designated representative to inspect the tank site prior to, during and after removal of the tank. The tank owner bears the responsibility to identify that the cause of the failure is from one of the events within the Conditions covered by the Warranty.
4. Upon the Warrantor's determination that the failure or leak is covered by this Limited Warranty, the Warrantor at its sole option shall: (1) repair the FLAMESHIELD® product; or (2) replace it with a tank or dike of approximately the same size, design, quality of material and workmanship specified for the original FLAMESHIELD® product; or (3) refund the purchase price of the original FLAMESHIELD® product. If the Warrantor is unable to repair or replace the tank, it shall refund the original purchase price of the FLAMESHIELD® product.

What is Not Covered by this Warranty

Warrantor does not warrant any piping system or any other attachments connected with the tank. Under no circumstances, shall the Warrantor be liable for (1) the cost of repair or replacement of any piping system or other attachments to the tank; or (2) labor costs or other installation costs for replacement of tank or dike; or (3) damage to the FLAMESHIELD® product or other property resulting from the accumulation of water in the tank or dike; or (4) damage caused by other improper operating or maintenance practices; or (5) tank failure due to defective materials and workmanship later than one year following delivery of the tank to the Owner or (6) cost of repair or replacement of internal linings or external coatings. This Warranty does not cover STI Generator Base Tanks.

Limitation of Liability and Exclusion of Other Remedies and Damages

The foregoing remedy of repair, replacement or refund shall constitute the sole and exclusive remedy to the Owner. Under no circumstances, shall the liability of the Warrantor, or its affiliates or subsidiaries, under this warranty, exceed the purchase price of the FLAMESHIELD® product.

IN NO EVENT SHALL THE WARRANTOR, OR ITS AFFILIATES OR SUBSIDIARIES, BE LIABLE FOR CLAIMS OF PERSONAL INJURY OR FOR SPECIAL, INCIDENTAL, INDIRECT OR CONSEQUENTIAL DAMAGES, INCLUDING, BUT NOT LIMITED TO, LOSS OF PROFITS OR REVENUE, LOSS OF USE OF THE TANK OR ANY ASSOCIATED EQUIPMENT, COST OF CAPITAL, COST OF THE SUBSTITUTE EQUIPMENT, FACILITIES OR SERVICES, DOWNTIME COST, CLAIMS OF CUSTOMERS OF THE OWNER FOR SUCH DAMAGES, OR FOR DAMAGE TO PROPERTY, WHETHER SUCH CLAIM SHALL BE FOR BREACH OF CONTRACT, BREACH OF WARRANTY, NEGLIGENCE OR STRICT LIABILITY, AND WHETHER SUCH CLAIM ARISES OUT OF OR RESULTS FROM THIS LIMITED WARRANTY, OR EXPRESS OR IMPLIED WARRANTIES, OR FROM THE DESIGN, MANUFACTURE, SALE, DELIVERY, RESALE, INSTALLATION, TECHNICAL DIRECTION OF INSTALLATION, INSPECTION, REPAIR, OPERATION OR USE OF THE TANK.

Consumer Notice

The exclusion of indirect or consequential damages and the limitation of implied warranties herein may not be applicable to purchasers who are deemed "consumers" and who reside in states that do not allow the limitation of implied warranties or the exclusion of indirect or consequential damages otherwise applicable to consumers. Moreover, if you are deemed a "consumer", you may have specific legal rights in addition to those set forth in this warranty, which rights vary from state to state.

Disclaimer of Other Warranties

THE FOREGOING LIMITED WARRANTY IS THE ONLY WARRANTY MADE. THERE ARE NO OTHER WARRANTIES, EXPRESS OR IMPLIED, INCLUDING, BUT NOT LIMITED TO, ANY IMPLIED WARRANTIES OF MERCHANTABILITY OR FITNESS FOR A PARTICULAR PURPOSE.

Financial Assurance

Warrantor may have purchased insurance to cover some of its warranty obligations under this Limited Warranty. Such insurance would provide financial assurance for Warrantor's warranty obligations, but would not insure the Owner directly. If the Warrantor has purchased such insurance coverage, the Owner may request that the Warrantor provide a certificate of insurance to evidence Warrantor's purchase of such insurance.

Effective with installations on or after January 1, 2009.

FLAMESHIELD®

INSTALLATION, TESTING & MAINTENANCE INSTRUCTIONS

1.0 TANK SITE EVALUATION AND PREPARATION PRIOR TO INSTALLATION

- 1.1 The foundation must be designed to support the tank plus 100% of its contents when full. The foundation design shall also take into account the type of support that is being used and the point load associated with that support. The foundation may be constructed using concrete, asphalt, gravel or other stable material and must include provisions in its design to prevent tank movement. The foundation should include any provisions necessary for seismic design.
The foundation design must also include provision for draining surface water away from the tank.
- 1.2 For tank installations without cathodic corrosion protection, the tank should be grounded in accordance with applicable electrical and fire code standards.
- 1.3 Where the steel tank body is in contact with the earth, use a zinc grounding rod. Do not use a copper ground rod.
- 1.4 Where the steel tank body is in contact with the earth or foundation, it should be protected from external corrosion. For external corrosion protection using cathodic corrosion protection, consult applicable standards (i.e., National Association of Corrosion Engineers) to provide the tank with appropriate protection from lightning without interference with the corrosion protection. Steel tanks in contact with the earth should not use copper grounding. Refer to STIR893-89, "Recommended Practice for External Corrosion Protection of Shop Fabricated Aboveground Storage Tank Floors."
- 1.5 Tanks located in areas subject to flooding must be protected against floatation.
- 1.6 Aboveground tanks should not be located above underground utilities or directly beneath overhead power lines.
- 1.7 The tank shall be protected from vandalism and accidental damage in accordance with all applicable codes, i.e., NFPA 30, NFPA 30A, UFC, etc., as well as local environmental regulations and safety codes. Consult local authorities before installing this tank.

2.0 TANK HANDLING

- 2.1 Do not handle or install the tank without having knowledge and experience in procedures involved with proper and safe installation of an aboveground tank used for storage of stable, flammable and combustible liquids.
- 2.2 Equipment for handling the tank shall be of adequate size to lift and position the tank. DO NOT DROP OR DRAG THE TANK.
- 2.3 Tanks shall be carefully handled using cables or chains of adequate length (with spreader bars, if necessary) and size. Attach to the tank using the lifting lugs provided. Care should be taken that the angle between the two cables, at the lift point, shall be no greater than 60 degrees.
- 2.4 DO NOT HANDLE OR MOVE THE TANK UNLESS IT IS EMPTY.
- 2.5 This is a stationary tank. Do not use this tank for transport of any product.

3.0 TESTING

3.1 GENERAL REQUIREMENTS

- 3.1.1 An on-site air test of the tank may be required by local authorities to ensure no damage has occurred in shipping and handling. All testing should be done as described below, or according to the tank manufacturer's specific instructions.
- 3.1.2 If the manufacturer has shipped the double wall tank with a vacuum drawn on the space between the walls, read and record the vacuum pressure. If the vacuum gauge reading is less than 12 inches Hg (40.5 kPa), contact the original tank manufacturer.
- 3.1.3 In lieu of the air pressure test described below, a vacuum may be applied to the interstice of a double-wall tank or to the interstice of a double-bottom tank. NOTE: This test procedure may be difficult to conduct for large (greater than 2000 gallons) tanks because of the size of the volume to be evacuated and difficulty in sealing the tank openings. DO NOT APPLY A VACUUM TO THE PRIMARY TANK OF A DOUBLE-WALL TANK OR TO A SINGLE-WALL TANK. A vacuum of 7" to 10" Hg is to be applied to the interstice and held for at least 24 hours with no more than a 2" Hg vacuum loss allowed. If this vacuum cannot be held for 24 hours, then perform the air test procedure described below.
- 3.1.3.1 Caution must be taken in applying a vacuum to the interstice of a tank and the testing must be stopped if any deformation appears on the tank.
- 3.2 AIR PRESSURE TEST PROCEDURE FOR TANKS
- 3.2.1 If the tank is equipped with a long-bolt manway for emergency venting, do not remove the long-bolts from the long-bolt manway. Instead, long-bolt manways must be secured with C-clamps of appropriate size and strength to hold the vent cover in the sealed position to maintain the tank pressures required. If the tank is equipped with standard emergency vents, remove emergency vents and cap openings to hold tank pressure as required.
- NOTE: Use only calibrated air pressure gauges with a 0-15 psig (0-103 kPa) dial span. The regulated air supply test pressure used for this test shall be as follows:

- Horizontal cylindrical tanks-Not less than 3 psig (20.7 kPa) nor more than 5 psig (34.5 kPa). Set pressure relief valve in test air supply line at 5.5 psi (38 kPa).
- Vertical tanks-Not to be less than 1½ psig (10.4 kPa) nor more than 2 ½ psig (17 kPa) or that gauge pressure above 1 ½ psig (10.4 kPa) which first causes visible deformation of the tank. Set pressure relief valve in test air supply line at 2 ½ psig (17 kPa).
- Rectangular tanks-Not more than 1 ½ psig (10.4 kPa). Set pressure relief valve in test air supply line at 1 ½ psig (10.4 kPa).

CAUTION: Do not leave pressurized tank unattended while pressure line/air line is connected. Do not stand in front of tank heads or fittings when pressurizing tank. Pressurizing of large tanks may result in the slight deformation of the top and bottom of vertical tanks, of the sides of rectangular tanks, and of the heads and ends of cylindrical tanks. Should deformation appear severe, immediately relieve the pressure. Aboveground vertical tanks may have a "weak shell to roof" seam. Do not air pressure test a tank with a "weak shell to roof" seam. Rather, fill these tanks with water and check for leaks.

3.2.2 TANK PRESSURIZING PROCEDURE

- 3.2.2.1 The following air pressure testing does not apply to double-wall tanks equipped with interstitial vacuum monitoring systems. (In lieu of the air pressure test, the tank may be shipped from the factory with a vacuum in the tank interstice. Read and record the vacuum pressure. If the vacuum pressure gauge reading is less than 12 inches Hg (40.5 kPa), contact the tank manufacturer).
- 3.2.2.2 Install the test piping as shown in Figure 2. Temporarily plug, cap or seal off remaining tank openings to hold pressure.
- 3.2.2.3 Close valves A and B. Open valve C.
- 3.2.2.4 Connect the regulated test air supply line to test piping as shown in Figure 2.
- 3.2.2.5 Slowly open valve A to pressurize the primary tank. Pressure gauge 1 should indicate test air pressure given in paragraph 3.2.1 above.

- 3.2.2.6 Close valve A. Disconnect regulated test air supply line from the test piping.
- 3.2.2.7 Monitor test pressure in primary tank for 1 hour minimum. A steady drop in pressure reading for gauge 1 indicates there may be a leak in the primary tank. Check the fittings, the gauge, and then retest. If the problem persists, contact the tank manufacturer.
- 3.2.2.8 If no leaks are found, close valve C and slowly open valve B to pressurize the interstitial space between the double walls of the tank.
WARNING: Do not apply air pressure to the interstitial space between the walls of a double wall tank without air pressure in the primary tank. Do not apply air pressure to the interstitial space that is higher than the air pressure in the primary tank. Damage to the tank may result. Pressure gauge 1 will indicate a slight drop in test pressure when valve B is opened, but should hold steady at the lower pressure. If the test pressure drops below the minimum requirements, close valve B, reconnect the air supply line and slowly open valve A to increase the pressure in the primary tank. When the required pressure is indicated on gauge 1 close valve A, disconnect the test air supply line. Open valve B to equalize the pressure in the primary tank and the interstitial space. Gauge 1 and gauge 2 should have the same pressure reading.
- 3.2.2.9 Close valve B. Hold the test pressure in the interstitial space for 1 hour minimum. A steady drop in pressure gauge 2 indicates there may be a leak in the interstitial space. Check the fittings, the gauges, and then retest. If the problem persists, contact the tank manufacturer.
- 3.2.2.10 Proceed to Section 3.2.3, "Detection of Leaks" below.
- 3.2.3 DETECTION OF LEAKS
- 3.2.3.1 Immediately apply the leak test solution to the tank exterior surfaces, welds, fittings, etc. Check for leaks. No leaks are allowed. If leaks are found, notify the tank manufacturer. If no leaks are found, testing of the tank is complete.
- 3.2.3.2 Open valve C, then slowly open valve B to release the test air pressure.
- 3.2.3.3 With tank depressurized, remove test piping, temporary plugs, caps and seals. Reinstall emergency relief vents, etc. which were removed in section 3.2.1 above. If tank is equipped with an emergency vent long-bolt manway, disconnect the C-clamps which were installed in Section 3.2.1 above.
WARNING: Emergency relief vents and long-bolt manways must be operable to prevent causing tank failure by over-pressurization.
- 4.0 TANK PIPING AND ACCESSORIES
- 4.1 Install all permanent piping and fittings using compatible, non-hardening thread sealant material.
- 4.2 All unused tank openings must be properly sealed and tested to be liquid and vapor tight prior to putting the tank into service.
- 4.3 DO NOT WELD ON THE TANK, MODIFY OR PENETRATE THE TANK STRUCTURE IN ANY WAY WITHOUT THE EXPRESS WRITTEN PERMISSION OF THE TANK MANUFACTURER.
- 4.4 All tank accessories shall be installed as required per local codes. Anti-siphon devices, overflow shut-offs and alarms, vents gauges, emergency vents, etc. are common requirements for tanks storing motor fuels for the purpose of being dispensed into motor vehicles.

5.0 LABELING

- 5.1 Tanks shall be labeled in accordance with all applicable codes.

6.0 MAINTENANCE

- 6.1 The tank operator should perform periodic walk-around inspections to identify and repair areas of damage to the vessel or the coating itself and check for proper drainage around the tank area.
- 6.2 It is imperative that the tank exterior be inspected periodically to ensure that the integrity of the coating is maintained. The frequency of periodic repainting will be based upon environmental factors in the geographic area where the tank is located. Special consideration should be given to the selection of the paint, surface preparation and coating application. The coating selected should be suitable for use with the current coating, or the existing coating should be removed. The coating selected should be of industrial quality.
- 6.3 Proper site preparation and maintenance are vital to ensure drainage of surface water. Should ground conditions change or settlement occur, take the appropriate steps to maintain proper drainage and prevent standing water near or under the tank area.
- 6.3.1 For diked tanks, remove any product spills immediately. Be sure to dispose of hazardous material properly.
- 6.3.2 For diked tanks fitted with a drain, drain off water only. Drain openings are required to be maintained liquid tight.
- 6.4 The primary tank shall be inspected monthly for the presence of water at the lowest possible points inside the primary tank. Remove any water found. Water and sediment in fuel can cause plugging of filters. Also, bacterial growth, originating from the fuel can cause corrosion of tanks and lines. For procedures on how to check for the presence of water and removal of water, refer to API Recommended Practice 1621, Appendix D and API Standard 2610. Another source of information is a report by the US Department of Energy Brookhaven National Laboratory, BNL 48406, which provides information on methods to test for and remove water, test for bacterial presence in fuel, tank cleaning and fuel additives.
- 6.5 failure to adhere with these maintenance instructions may void your warranty.
- 6.6 Tank relocation requirements - often aboveground storage tanks are relocated. The following instructions are to be followed when this occurs: All steps are to be documented and the documentation is to be kept for the life of the tank.
- 6.6.1 The hazards associated with the cleaning, entry, inspection, testing, maintenance or other aspects of ASTs are significant. Safety considerations and controls should be established prior to undertaking physical activities associated with ASTs. Cleaning of tanks must be per state and local jurisdiction requirements.
- 6.6.2 Refer to the STI Standard SP001, "Standard for the Inspection of Aboveground Storage Tanks" for requirements concerning tank inspections. This SP001 Standard details requirements for inspections based on the tank installation and age. A tank must undergo the appropriate inspection prior to relocation.
- 6.6.3 In addition, the tank must be subjected to a pressure (or vacuum) test as detailed paragraph 3.2 above except an inert gas, such as nitrogen, should be used for tanks that have previously held fuel.

Disclaimer: These instructions are intended only as an aid to tank installers who are knowledgeable and experienced in aboveground tank installation. Compliance herewith does not necessarily meet the requirements of applicable federal, state and local laws, regulations and ordinances concerning tank installation. STI makes no warranties, express or implied, including but not limited to, any implied warranties of merchantability or fitness for a particular purpose, as a result of these installation instructions.

This information furnished as a service of a Steel Tank Institute member.

© Copyright Steel Tank Institute. All rights reserved for exclusive use of Flameshield® licensees.

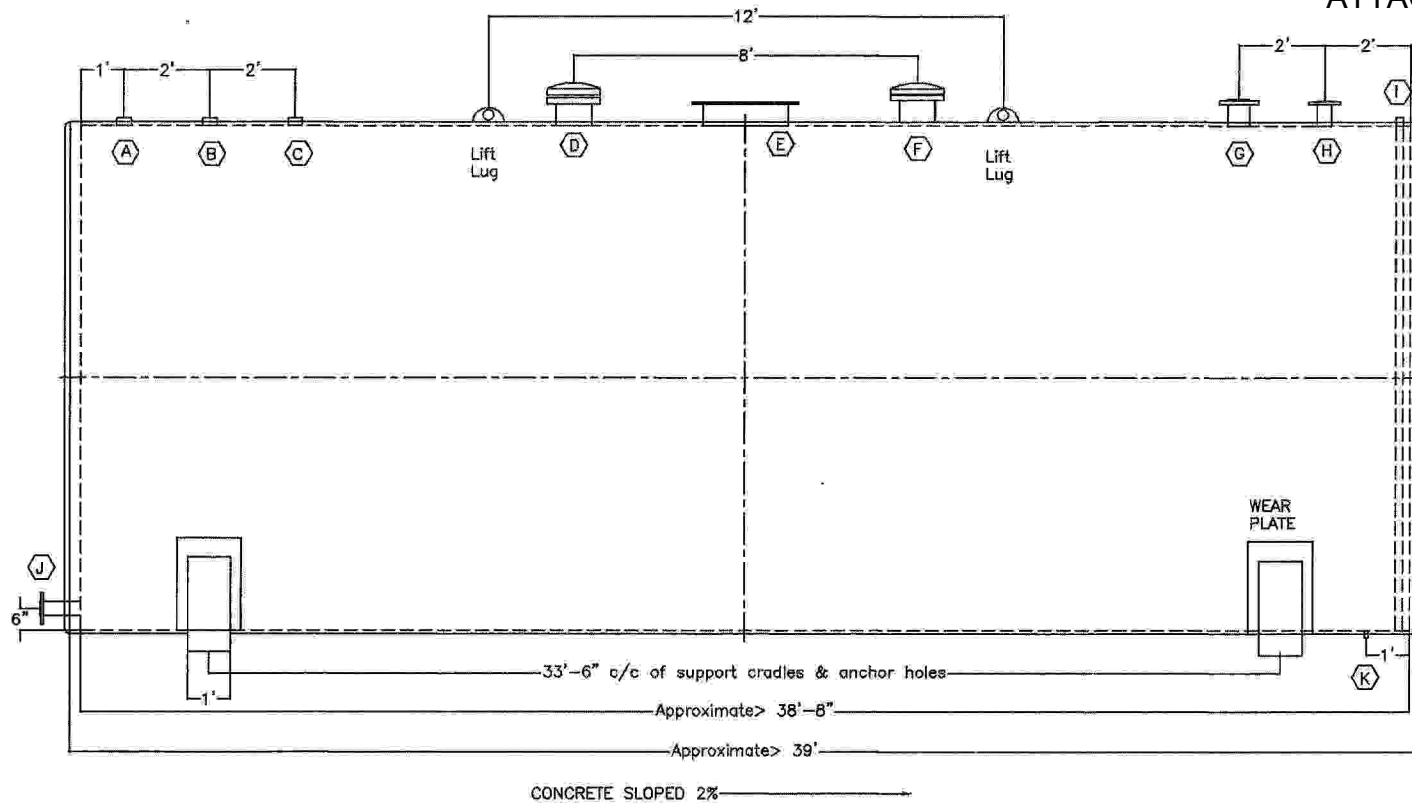

OPENINGS>

- A. 4" FNPT FITTING
- B. 4" FNPT FITTING
- C. 4" FNPT FITTING
- D. 10" 2440F PRIMARY EMERGENCY VENT INSTALLED
- E. 24" BOLTED ACCESS MANWAY
- F. 10" 2440F SECONDARY EMER. VENT INSTALLED
- G. 6" 150# RFSO FLANGE
- H. 4" 150# RFSO FLANGE
- I. 2" INTERSTITIAL MONITOR PIPE
- J. 4" 150# RFSO FLANGE
- K. 1" FNPT FITTING FOR WATER DRAW OFF

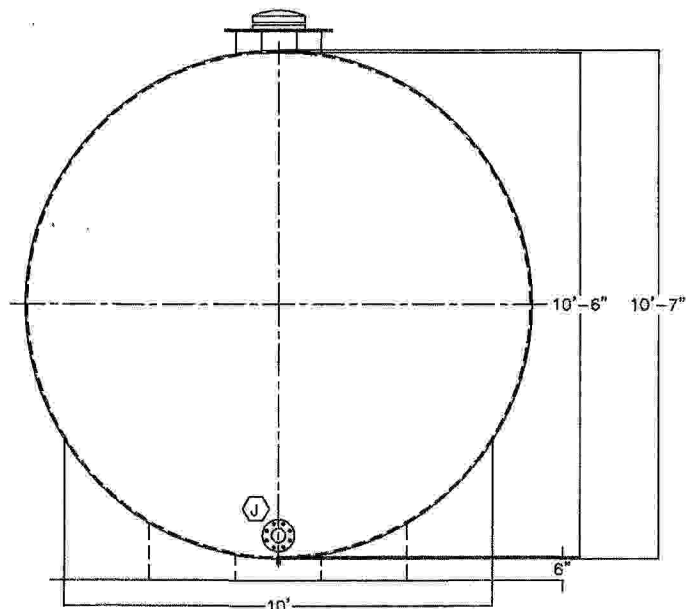

BIRKSHIRE JOHNSTONE

Ref. PO# 050, (2) - 25000 gallon Flameshield horizontal storage tanks with support cradles

Manufactured by Alabama Tank, Inc.
Aimore, Alabama 1-800-522-8265

Constructed, labeled, and leak tested to UL-142, STIF921 & SWRI 97-4 specifications. EQ# 677

1/4" A-36 carbon steel primary
3/16" A-36 carbon steel secondary

Approximate empty weight: 30,000 lbs.
Lifting lugs are designed for the empty weight of the tank only

Sandblast - SSPC6 Sherwin Williams 940DTM polyurethane exterior (color undetermined)
Sandblast - SSPC10 Sherwin Williams Phenicon two coat epoxy (white topcoat) interior



MEMORANDUM

Date: January 9, 2020

To: File – 2019.050.01/Meetings

CC: Meeting Attendees (noted on attached sheet)

From: John Collins, AVCON, Inc. (850-678-0050) 

Re: Minutes from Pre-Bid Conference on January 9, 2020
VPS Fuel Farm Fall Protection project
Destin-Fort Walton Beach Airport

MINUTES

A project Pre-Bid Conference was held on January 9, 2020 from 11:00 - 11:30 a.m. in Conference Room No. 1 at the Destin-Fort Walton Beach Airport.

The following minutes represent a summary of the salient issues discussed. They are not intended to be a verbatim transcript of the meeting or a part of the contract documents. These minutes are for informational purposes only.

A copy of the meeting agenda, PowerPoint presentation, and a list of meeting participants are attached.

END OF MINUTES

**VPS FUEL FARM FALL PROTECTION
DESTIN-FORT WALTON BEACH AIRPORT**

**PRE-BID CONFERENCE
January 9, 2020 11:00 a.m.**

AGENDA

I. INTRODUCTION OF PARTICIPANTS

- A. Owner -** Okaloosa County
- B. Engineer-** AVCON, INC.
- C. Funding Agency -** Okaloosa County, Florida Department of Transportation (FDOT)

II. PURPOSE

To provide a review of the Release for Bid documents, schedule, and construction considerations.

III. PROJECT ELEMENTS

A. Scope of Work

- 1. Catwalks
 - a. Review of existing platforms and proposed catwalks
 - b. Interior catwalks on Tanks 1 and 2, and 7 and 8
 - c. Provide openings for tank penetrations, covered by McNichols fiberglass grating
 - d. All steel hot dip galvanized
 - e. Contractor shall field verify all dimensions prior to construction
 - f. Re-route existing fuel lines on Tanks 7 and 8
 - g. No welding allowed within 100 ft of tanks. Any welding must occur at least 100 ft from the tanks. Majority of connections are bolted.
- 2. Pad-eyes and cables (Additive Alternate No. 2)

B. Bid Schedule

- 1. Base Bid – New catwalks for Tanks 1 through 6
- 2. Additive Alternate No. 1 – Catwalks for Tanks 7 and 8
- 3. Additive Alternate No. 2 – Pad-eyes and cables for tanks 7 and 8 without additional catwalks for Tanks 7 and 8

C. Safety and Security

- 1. Always leaves gates closed
- 2. No smoking inside fence

IV. ADMINISTRATION

A. Project Schedule and Time

- 1. Last day for questions is Wednesday, January 15 by 3 pm CST
- 2. Bids due on Wednesday, January 29 until 3:00 pm CST
- 3. Meeting with Low Bidder to Review Bid
- 4. Contract Award, within 60 days
- 5. Duration and Time of Completion, 120 days to substantial, 140 to final
- 6. Liquidated Damages, sliding scale, OC Standard Clauses 6 of 6

B. Contract Documents

- 1. Lump Sum price
- 2. Basis of Award

3. \$1M general liability insurance, Builders Risk, see Okaloosa County Standard Clauses, page 4 of 6

C. Contractor Questions - Address in writing NLT close of business on Wednesday, January 15, 2020 by 3 pm CST. Attn: Jessica Darr (jdarr@myokaloosa.com)

V. QUESTIONS AND ANSWERS

END OF AGENDA

PRE-BID CONFERENCE SIGN-IN SHEET

January 9, 2020 at 11:00 a.m. Central

VPS Fuel Farm Fall Protection
Destin-Fort Walton Beach Airport

NAME	REPRESENTING	TELEPHONE	E-MAIL ADDRESS
Tracy Stage	Okaloosa County Airports	850-651-7160	tstage@myokaloosa.com
<i>CR</i> Chad Rogers	Okaloosa County Airports	850-651-7160	rrogers@myokaloosa.com
Allyson Oury	Okaloosa County Airports	850-651-7160	aoury@myokaloosa.com
Mike Stenson	Okaloosa County Airports	850-651-7160	mstenson@myokaloosa.com
<i>RB</i> Raymond Beasley	Okaloosa County Airports	850-651-7160	rbeasley@myokaloosa.com
<i>OW</i> Oscar Williams	Okaloosa County Airports	850-651-7160	owilliams@myokaloosa.com
<i>TK</i> Terry Kerwell	Okaloosa County Airports	850-651-7160	tkerwell@myokaloosa.com
<i>JC</i> John Collins	AVCON INC.	850-678-0050	jcollins@avconinc.com
<i>CD</i> Chadman	Purchasing	689-5960	chadman@myokaloosa.com
Jessica Darr	Purchasing	689-5960	jdarr@myokaloosa.com

VPS Fuel Farm Fall Protection

Pre-Bid Conference, January 9, 2020 at 11:00 AM



VPS Fuel Farm Fall Protection



VPS Fuel Farm Fall Protection

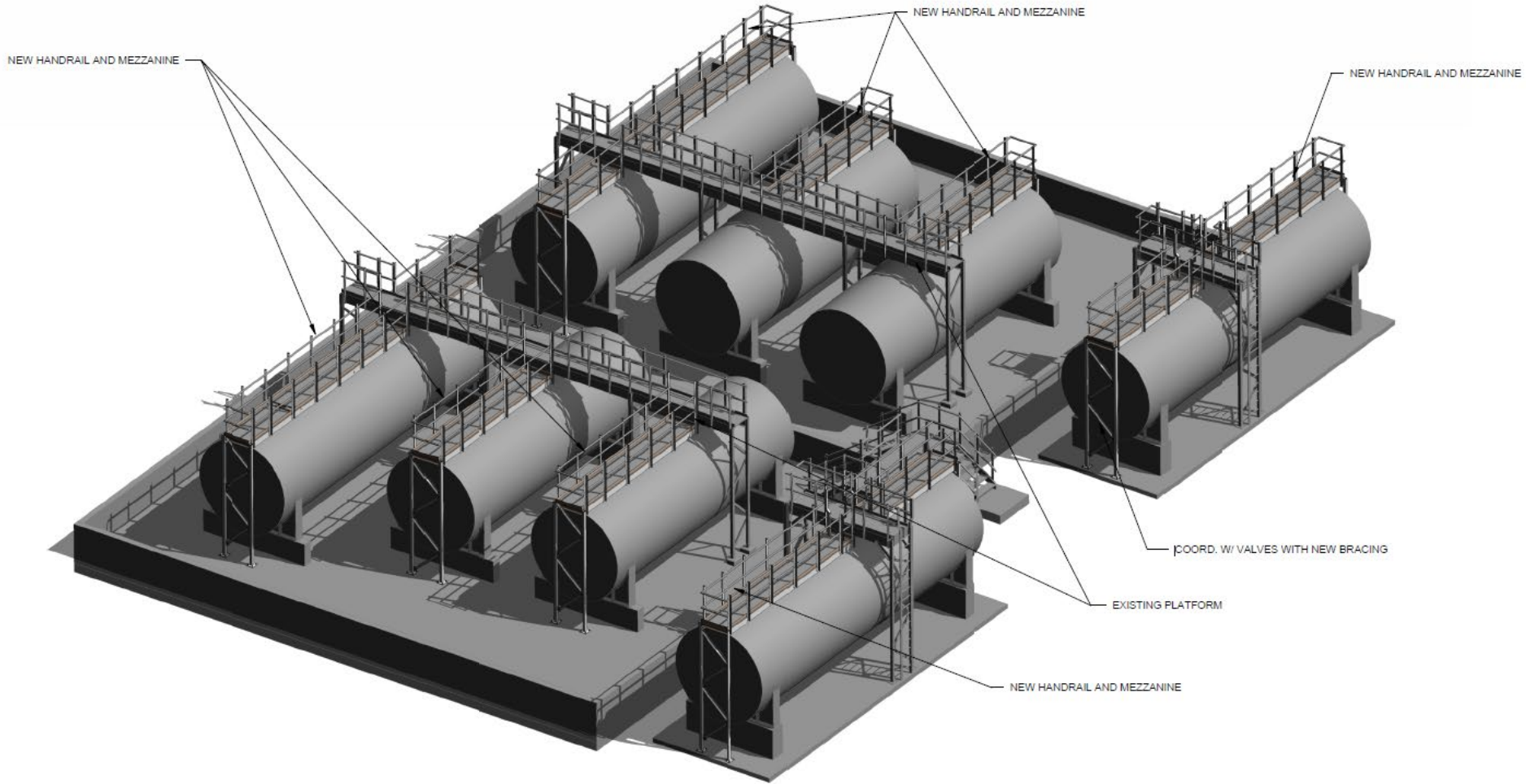

VPS Fuel Farm Fall Protection

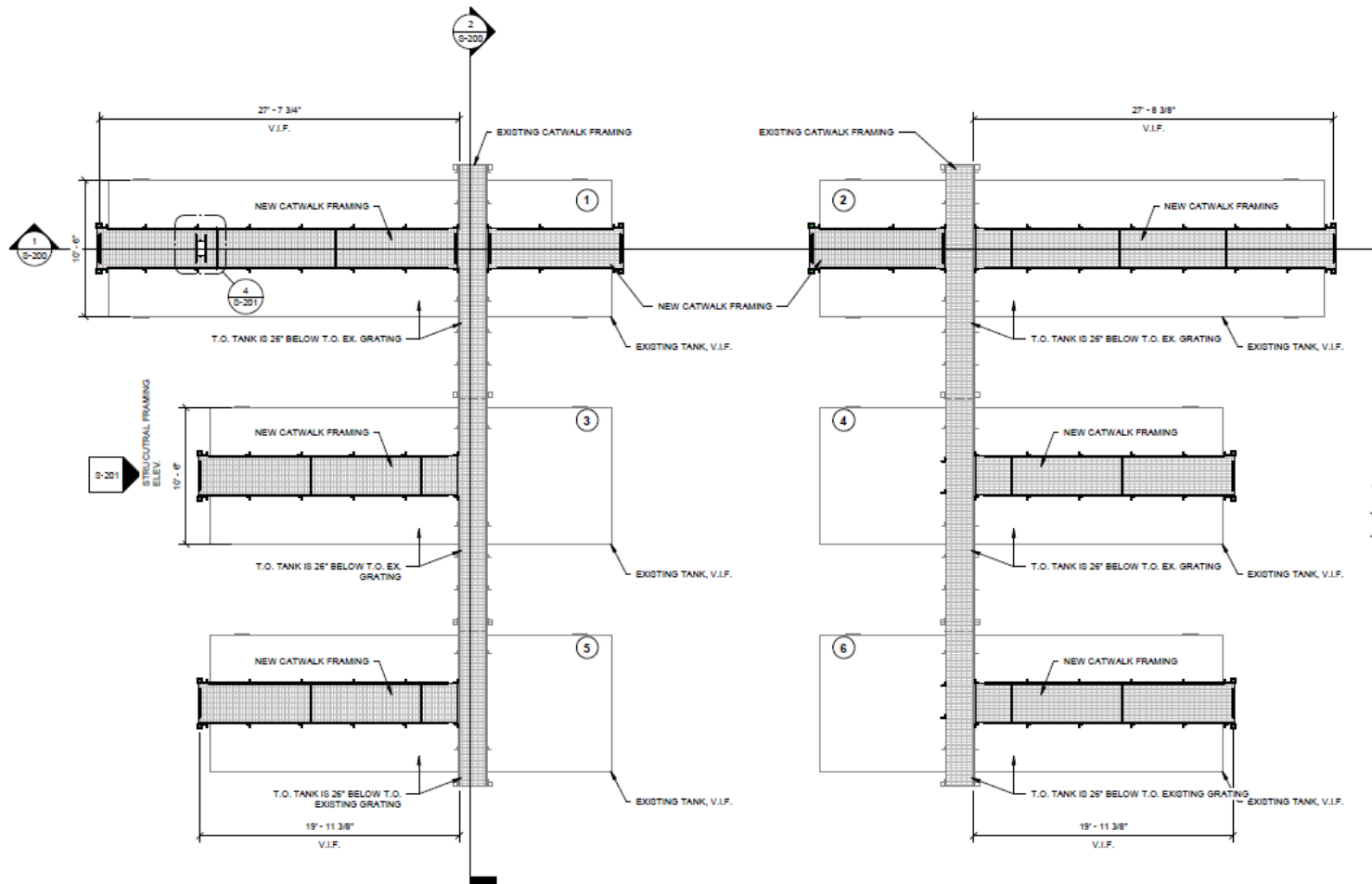

1. THE CONTRACTOR SHALL BE RESPONSIBLE FOR THE PROPER INSTALLATION.
2. TANKS 7 & 8, AS BID OPTION 1: IN LIEU OF PROVIDING CATWALK, PROVIDE COST TO INSTALL (4) PAD-EYES FOR INSTALLATION OF HORIZONTAL LIFELINE SYSTEM. THE CONTRACTOR SHALL PROVIDE THE HORIZONTAL LIFE LINE SYSTEM CAPABLE OF RESISTING A 5000 LB POINT LOAD IN ANY DIRECTION.
3. PROVIDE OPENINGS FOR PENETRATIONS AS REQUIRED. FIELD FIT AND CUT ANGLES AS REQUIRED. AFTER MODIFYING ANGLES, COLD GALVANIZE ANY EXPOSED END.
4. FOR ALL NEW CATWALKS, PROVIDE MCNICHOLS FIBERGLASS GRATING FULTRUDED, I-BAR, MS-15015 - DURAGRID, SPF POLYESTER RESIN, GRAY, 1.5\"/>

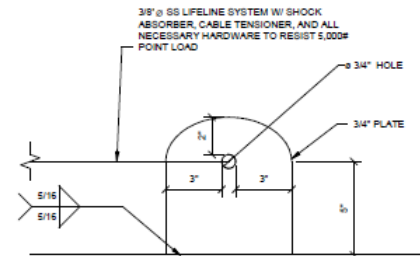

② BID OPTION - FALL PROTECTION PAD EYE
3\"/>

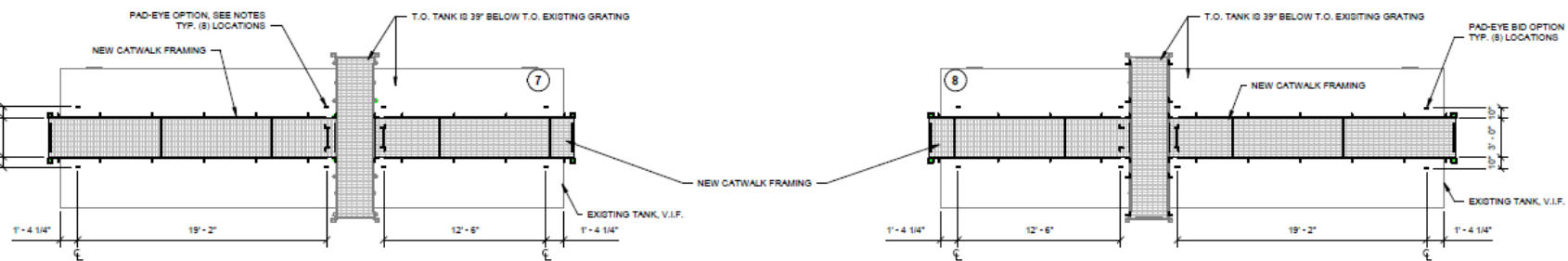

VPS Fuel Farm Fall Protection



1 TANK #8 PLAN EAST VIEW
3/4" = 1'-0"



2 TANK #8 PLAN WEST VIEW
3/4" = 1'-0"



3 TANK #7 PLAN WEST VIEW
3/4" = 1'-0"



4 TANK #7 PLAN EAST VIEW
3/4" = 1'-0"



5 TANKS #1, #3, #5 PLAN WEST VIEW
3/4" = 1'-0"



6 TANK #2 PLAN WEST VIEW
3/4" = 1'-0"



7 TANK #1 PLAN EAST VIEW
3/4" = 1'-0"